

## LOWARA 1300 SERIES 1315 VORTEX OR NON-CLOG SUBMERSIBLE PUMP

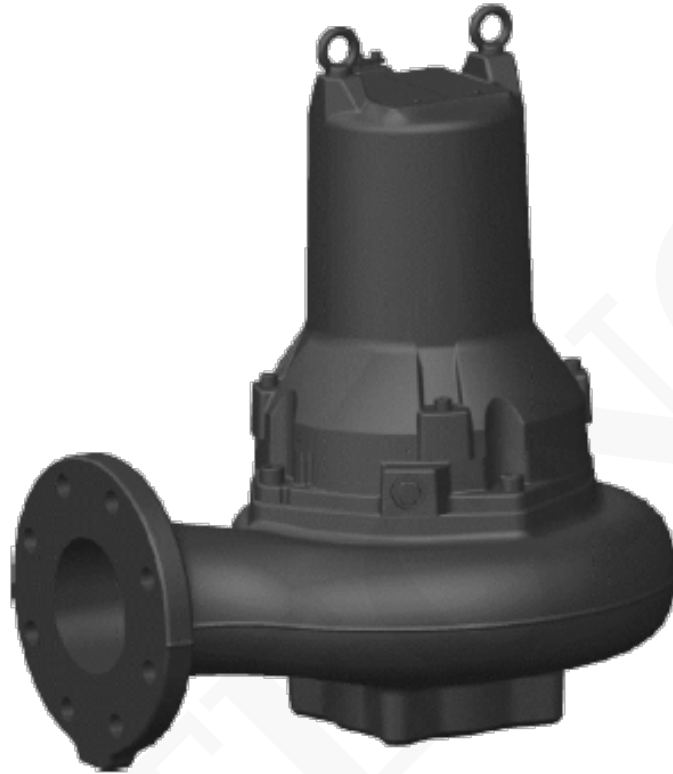

**SKU:** 1315,181 / 50 | **Categorías:** [Equipo Analítico](#) |

## DESCRIPCIÓN DEL PRODUCTO

### LOWARA 1300 SERIES 1315 VORTEX OR NON-CLOG SUBMERSIBLE PUMP

Part Number: 1315,181 / 50

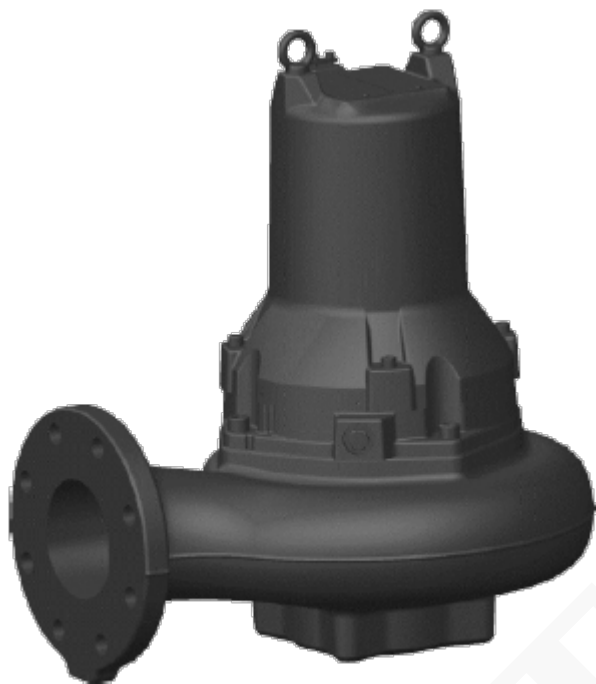

#### Especificaciones

Marca	Lowara 1300 series
Flujo l/min	1440
Motor	3~ 400V 50Hz
Motor rpm	2855
Potencia kW	4.4
Potencia en HP	5.9
Temperatura máxima °C	40

#### Dimensiones / Pesos

Observaciones Watch the PDF for all variance in types



The Lowara 1300 series is a submersible pump line that delivers pure performance at outstanding value. Combining performance and quality, in a convenient package that delivers value for money, will help ensure the smooth running and profitability of your operation.

This is why Lowara pumps are ideal for sewage and surface wastewater within commercial building applications.

Lowara makes pump specification easy in three simple steps.

[Ver PDF](#)

COTECNO

## INFORMACIÓN ADICIONAL

COTECNO