

NOCCHI SUBMERSIBLE DHR 4-20 T MULTI-CELL CENTRIFUGAL PUMP

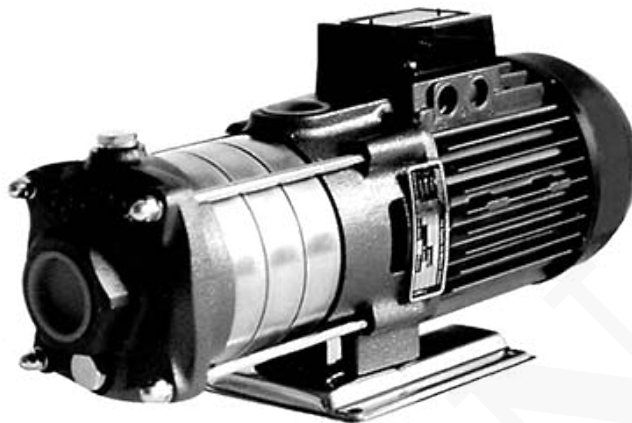

SKU: DHR 4-20 T | **Categorías:** [Equipo Analítico](#) |

DESCRIPCIÓN DEL PRODUCTO

NOCCHI SUBMERSIBLE DHR 4-20 T MULTI-CELL CENTRIFUGAL PUMP

Part Number: DHR 4-20 T

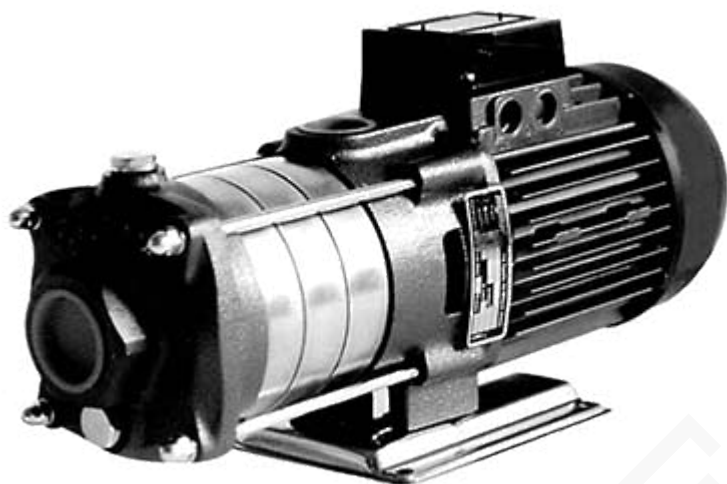

Especificaciones

Marca	Nocchi Submersible
Tipo	MULTI-CELL CENTRIFUGAL PUMP
Presión máxima bar	10
Flujo l/min	40-120
Flujo m ³ /h	2.4-7.2
altura de elevación m	17-7
Entrada	1"1/4
Salida	1"
Potencia kW	0.53
In A	2.1-1.2

Dimensiones / Pesos

Brida mm	NA
DN in	32
Peso kg	10.5
Aplicación	Handling of aggressive, distribution, pressure boosts, irrigation, fountains

[Ver PDF](#)

INFORMACIÓN ADICIONAL

COTECNO